



T- Hangar Diagrams

Northeast T-Hangars

	=	\$517.00
	=	\$590.00
	=	\$703.00

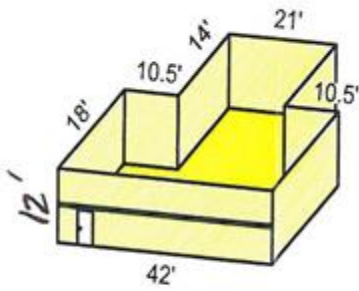

BAY 1 - 7

Approx. 1,050 sq. ft.

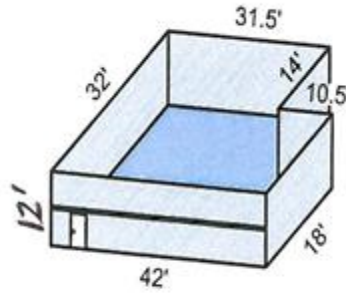

BAY 8

Approx. 1,197 sq. ft

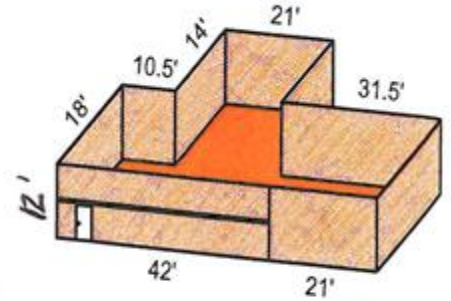

BAY 2X

Approx. 1,428 sq. ft.

Northeast T-hangar

Approximate door opening height: 11'8"

**Prices will adjust May 1st.*

T- Hangar Diagrams Southwest T-Hangars

N54-42

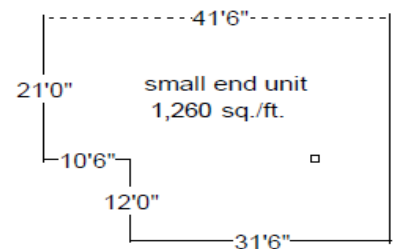
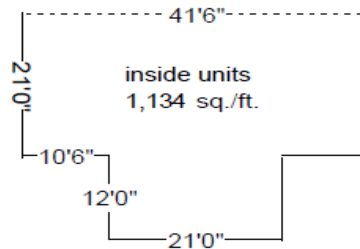
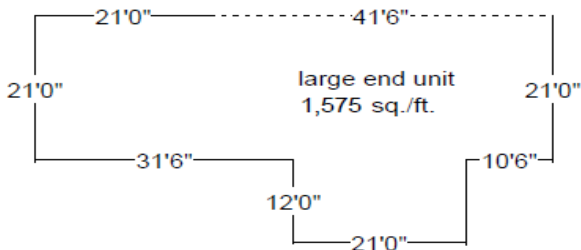

N60-45

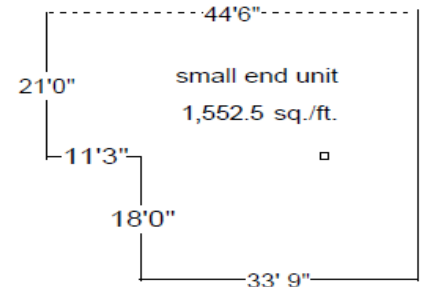
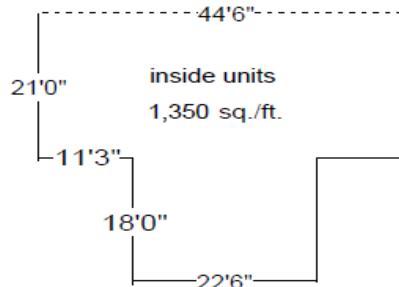
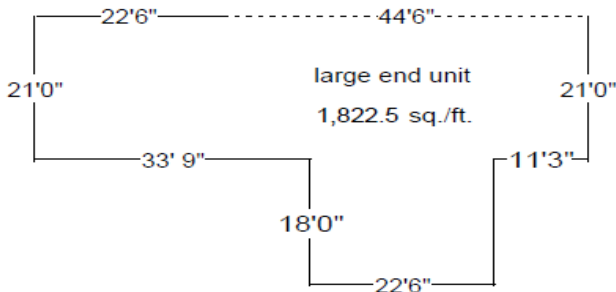

N54-42 (TH50)

Large End Unit (50-2) = \$749.00

Inside Units (50-3 thru 50-10) = \$539.00

Small End Unit (50-1) = \$599.00

Approximate door opening height: 11' 4"

N60-45 (TH51)

Large End Unit (51-9) = \$866.00

Inside Units (51-1 thru 51-8) = \$642.00

Small End Unit (51-10) = \$738.00

Approximate door opening height: 13' 5"

**Prices will adjust May 1st.*